

VM-15 SERIES MONITOR

Model VM-15 TREND MEMORY FUNCTION

INSTRUCTION MANUAL

FOR THE SAFE OPERATION OF THIS UNIT...

Thank you for using the MODEL VM-15 Series Monitor.

SHINKAWA Sensor Technology, Inc. applies strict inspection and quality control standards to ensure the high reliability of its products.

Please study the contents of this and related manuals carefully before installing or operating the equipment.

Keep them handy for future reference.

REGARDING 'PRECAUTIONS'

Please read and understand completely the Precautions on pages ii-v of this manual before using this or any of our products.

'Indicators' and other symbols that are used in the Precautions section appear throughout this manual on the left side of the page.

This product is designed to be used by specialists or persons with a thorough knowledge of our products. Please make certain that the end user receives the instruction manual delivered with this product.

BEFORE USING...

After this system is delivered, inspect it for possible damage that occurred during shipment, and be sure it is the item that was ordered. In the unlikely event it was damaged or does not function according to specification, please contact the SHINKAWA office or dealer nearest you.



Store this system under the ambient conditions given in the specification. Avoid places where it may be exposed to high humidity or corrosive gases, but rather in the environmental conditions specified in the manual.

Follow closely all instructions written in the manual.

Important information is contained in this manual that will prevent serious injuries to individuals and damage to this product and other equipment.



Read and understand the contents of this section, including the Indicators and Symbols, before reading other sections of the manual.

■ Indicators

Indicator	Description
 DANGER	If this unit is not handled properly, dangerous situations may occur that could result in death or serious injury .
 WARNING	If this unit is not handled properly, dangerous situations may occur that could result in slight or moderate injury , or damage to the unit or other equipment.



- ◇ “**Serious injury**” means loss of sight, cuts, burns by high or low temperatures, electrocution, broken bones, poisoning, etc. which would require hospitalization or long-term outpatient care, and unpleasant after-effects.
- ◇ “**Slight or moderate injury**” refers to cuts or electrical shocks that would not require any hospitalization or long-term outpatient care. “Damage to equipment” refers to breakage of a single unit or to destruction of several pieces of equipment.

■ Other Symbols





Symbol	Description
	Prohibited. Details may be found inside or near the symbol, and further explained in words or pictures.
	Mandatory. Details may be found inside or near the symbol, and further explained in words or pictures.

In order to use this unit safely, strictly follow the installation and operation instructions that are required by law, and observe all warnings as described in this manual. SHINKAWA Sensor Technology does not accept responsibility for the misuse of this or any of its products.

■To Use This Unit Safely

 DANGER	
 Grounding	A ground connection is mandatory. Failure to do so may cause electrocution or improper operation of the unit.
 Prohibited	Do not perform wiring work while the power supply is on. This may result in electrocution.

■To Use the VM-15 Monitoring System Safely

 WARNING	
 Prohibited	Since this monitoring system is a highly precise instrument, care should be taken while handling so that there are no heavy shocks or excessive vibration.
 Prohibited	Do not set up any specifications while the unit is in operation. Alarm contact might cause output.
 Prohibited	Do not touch the main board of this unit. Instruments may be damaged and cause incorrect operation of the system.
 Prohibited	Do not remodel without permission. The product guarantee will be voided.

■EMC (Electro-Magnetic Compatibility)

The VM-15 series monitoring system has an excellent reputation for EMC features. However, these characteristics may be affected depending upon the surrounding conditions, such as the amount of generated noise, temperature, humidity or machine arrangement.

Therefore, please study the Precautions below before using this unit.

 WARNING	
 Mandatory	This unit should be used by specialists or persons with a thorough knowledge of our products.
 Mandatory	Do not use radio instruments near this unit.

■Noise Filters

Inserting the FERRITE CORE (see note 1) is effective in preventing noise mediated through cables. In case the surrounding conditions are poor, the use of any parts, including this part, in order to prevent noise is highly recommended.

(note 1) ZCAT3050-1330 : TDK

1. GENERAL	
.....	1
2. SPECIFICATONS	
2-1 SPECIFICATION	2
3. OUTLINE DRAWING	
3-1 OUTLINE DRAWING	3
4. FUNCTION DESCRIPTION	
4-1 CARD SLOT	4
5. PART NAMES AND DESCRIPTIONS	
5-1 PART NAMES ON THE FRONT PANEL	5
5-2 PART NAMES AND DESCRIPTION	6
5-3 DATA STORAGE DESCRIPTION	7
6. SCREEN DESCRIPTIONS AND KEY OPERATION METHOD	
6-1 DIGITAL INDICATOR DESCRIPTION	9
6-2 MEMORY CARD FUNCTION SETUP	10
7. MAINTENANCE AND INSPECTION METHODS	
7-1 CONTENTS OF PERIODIC INSPECTION AND MAINTENANCE	18
7-2 PERIODIC INSPECTION AND MAINTENANCE CHECK LIST	18
7-3 CONFIRMATION OF MEMORY CARD SLOT	19
8. TROUBLESHOOTING	
.....	20

The VM-15 Series Monitoring System monitors the operating condition of rotating machinery, using the signals from the transducer that is installed in the rotating machinery. When the optional Memory Card Unit is implemented, it is possible to store the measured values or alarm status, etc., on the memory card, and data edition or analysis can be easily performed.

2-1 TREND MEMORY FUNCTION SPECIFICATION

Memory Card Slot	
<p>Memory contents</p> <ul style="list-style-type: none"> • Vibration Value • Input Voltage (GAP voltage) • Alarm Status • Sampling Time • External Operation Contact Status (Reset, Sequence Contact) • Alarm Set Value • Alarm Relay Mode • Alarm Reset Mode • Alarm Delay Time • Sequence Set Value • Suppression Set Value • Input Abnormal Alarm Set Voltage Value <p>Sampling Time</p> <p>10 sec. ~ 24 hrs. (Can be set up in 10 sec. increments)</p> <p>File</p> <p>File Type : Text File Name : log1.txt, log2.txt</p>	<p>Recording Media</p> <p>Recommended Memory Card : CompactFlash™ Manufactured by SanDisk Recommended Memory Capacity: 32MB, 64MB Others : Compact Flash Card Adapter is needed Recording Time : Approx. 30 days when 10 sec. sampling is set up. (Memory Capacity 32MB is used)</p> <p>Display</p> <p>Busy Status : Yellow LED Stand-by Status : GreenLED Communication Error Status : Green LED flashes Card Not Inserted Status : Red LED</p> <p>Others</p> <hr/> <hr/> <hr/> <hr/> <hr/> <hr/> <hr/> <hr/>

CompactFlash™ is Trademark of SanDisk corporation.

For specifications other than the Trend memory function, refer to the VM-15 Master Instruction Manual.

3. OUTLINE DRAWINGS

VM-15

3-1 VM-15 MONITORING SYSTEM (with Memory Card Slot) OUTLINE DRAWING

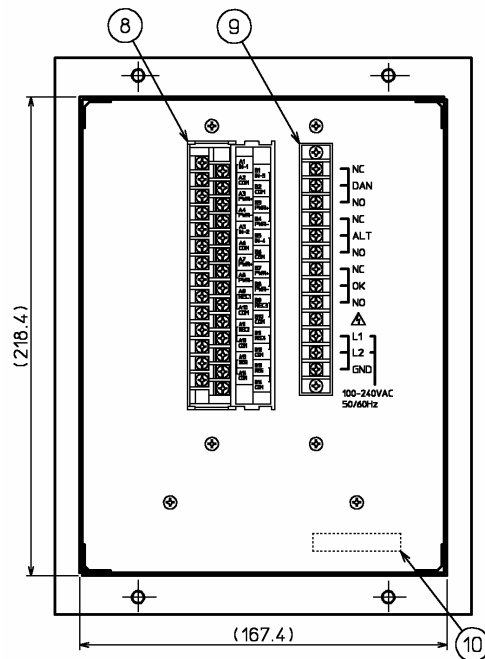
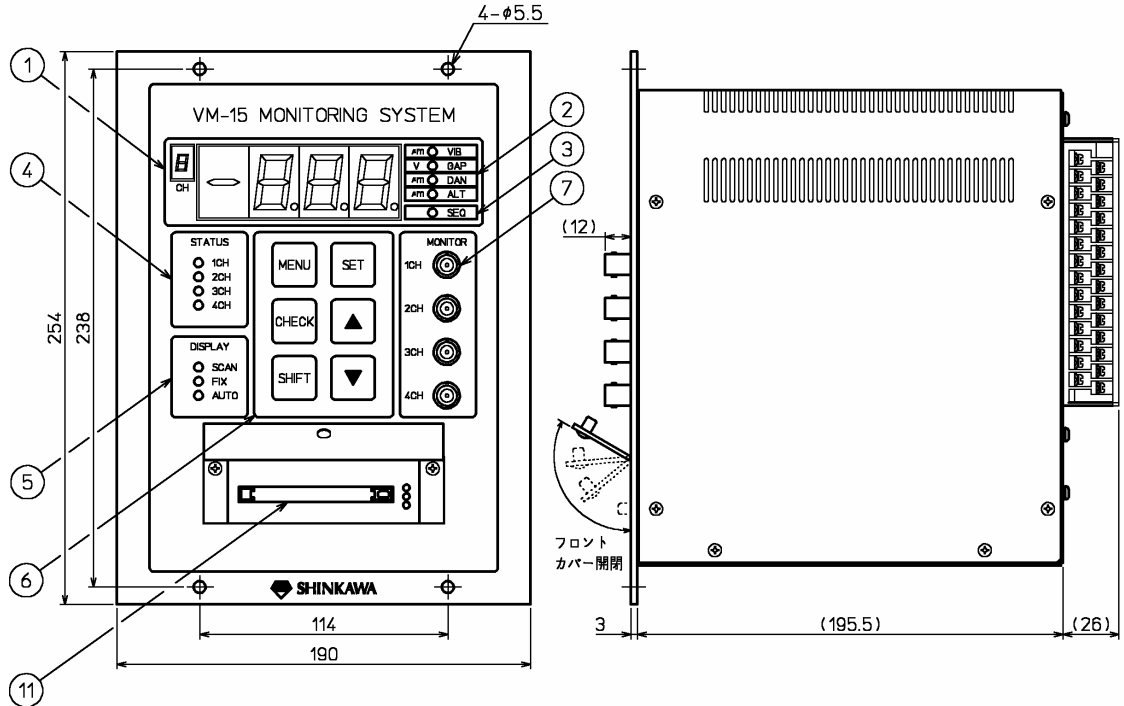

No.	NAME	REMARK
1	Digital Display	7-Segmental LED
2	Unit Display Lamp	LED(Red)
3	Sequence Lamp	LED(Yellow)
4	Status Lamp	Bi-color LED(Red/Green)
5	Display Mode Lamp	LED(Yellow)
6	Operation Key	
7	Monitor Output	BNC
8	Input/Output terminal	Screw:M3 Terminal Pitch:7.62mm
9	Power Supply Input/ Alarm Contact Output Terminal	Screw:M3 Terminal Pitch:7.62mm
10	Serial Number Plate	
11	Memory Card Slot	

Unit : mm

4-1 CARD SLOT

Store the vibration values of each channel onto the memory card. The recording media that can be used is a widely available CompactFlash™ card. Insert it into the card slot via the card adapter.

Data that can be stored are listed below:

- Vibration Value
- Input Voltage (GAP voltage)
- Alarm Status
- Sampling Time
- External Operation Contact Status (Reset, Sequence Contact)
- Alarm Set Value
- Alarm Relay Mode
- Alarm Reset Mode
- Alarm Delay Time
- Sequence Set Value
- Suppression Set Value
- Input Abnormal Alarm Set Voltage Value



- **Do not insert any cards like an LAN card or Modem, etc. This may cause damage to the card or the memory unit.**



- **For recording media, use the CompactFlash™ card. If other media are used, data storage may not be properly performed.**



- **Do not move, remove or service unless power has been switched off or area is known to be non-hazardous.**



- **CompactFlash™ memory card has a limit to the rewritable number of times, and it may be unable to rewrite and/or read over the limit. Refer to the manual attached to CompactFlash™ or confirm to the CompactFlash™ manufacturer about the limit.**

5. PART NAMES AND DESCRIPTIONS

VM-15

5-1 PART NAMES ON THE FRONT PANEL

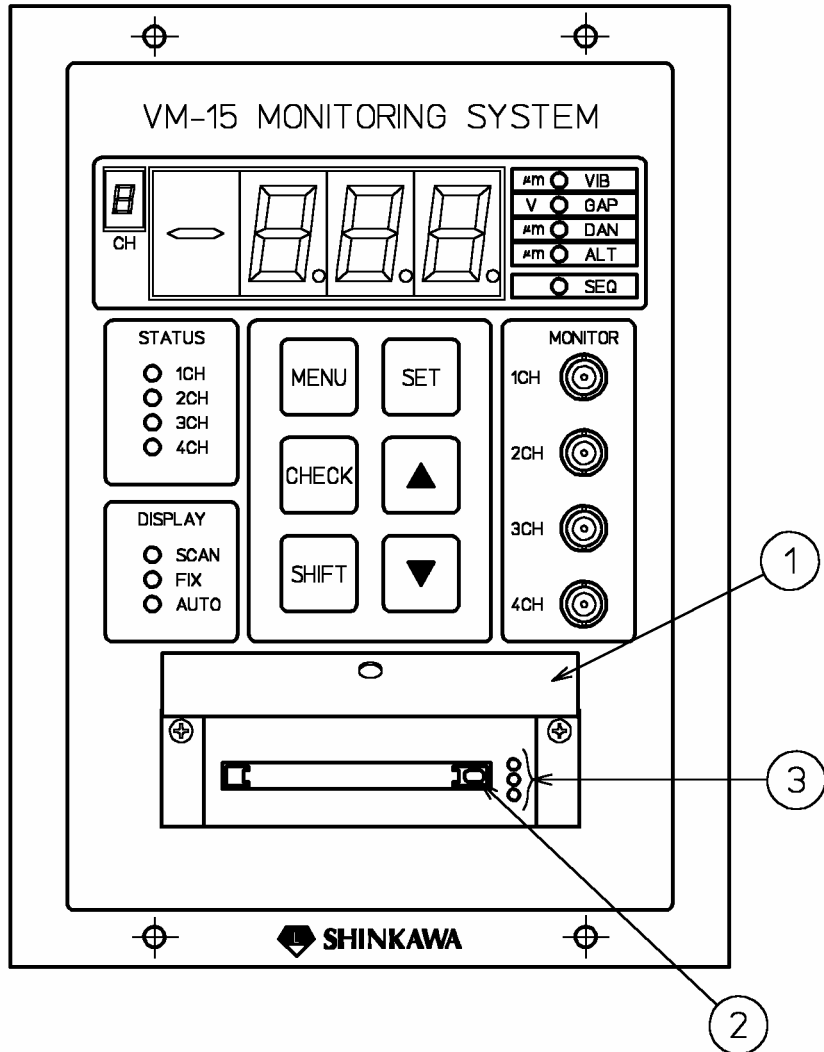

No.	Name
1	Front Cover
2	EJECT Button
3	Display Lamp

5-2 PART NAMES AND DESCRIPTIONS

① FRONT COVER

Protects the memory card slot. In order to eject the memory card, hold the knob and open the cover.

② EJECT BUTTON

Use it to remove the memory card. Push the button and the card is ejected out the front of the unit. The memory card should be ejected when the BUSY lamp is off.



• **Use the EJECT button to remove the memory card. If the memory card is forcibly removed, it may cause damage.**



• **Do not move, remove or service unless power has been switched off or area is known to be non-hazardous.**

③ DISPLAY LAMP

BUSY Status
(Yellow LED)

- While the data transfer from the VM-15 main body to the memory card is in progress, a yellow LED is lit. Confirm the BUSY lamp is off before ejecting the memory card. A lamp is lit for every sampling time regardless to card installation.

STAND-BY Status
(Green LED)

- When communication between the VM-15 and the memory card unit is possible, a green LED is lit.

COMMUNICATION
ERROR Status
(Green LED)

- When the communication between the VM-15 and the memory card unit is in an abnormal condition, a green LED flashes. When a communication returns, LED is lit to normal condition in 10 seconds.

CARD NOT
INSERTED Status
(Red LED)

- When the memory card is not inserted, a red LED is lit. In case the memory card is removes, a lamp is lit in 10 seconds maximum, and if inserted, the light is illuminated in 10 seconds maximum.



• **Do not insert any cards like an LAN card or Modem, etc. This may cause damage to the card or the memory unit.**



• **For recording media, use the CompactFlash™ card. If other media are used, data storage may not be properly performed.**

5-3 DATA STORAGE DESCRIPTION

Sample trend data is stored in the memory card as a text file. When an application such as Excel, etc., is used, data edition or analysis is possible.

FILE TYPE : Text file

FILE NAMES : log1.txt, log2.txt

File is automatically produced and the same data is stored in 'log1.txt' and 'log2.txt'. Cut and paste the file (log.txt) containing the data from the CompactFlash memory card to the computer. Do not leave the old data file in the CompactFlash memory card after completion of saving the data into the computer, or can not be storage the new data in the CompactFlash memory card when reinstalling the memory card to the VM-15.

Recording Time : Approx. 30 days when 32MB memory card is used.
(10 sec. sampling time)



Warning

- **Recording time varies depending upon the sampling time, measured range, header, etc. Data should be transferred to a personal computer as soon as possible.**

HEADER : When a setup change is performed, or a memory card is inserted, data is stored as a header, following the order below:

- (Contact output setup, DAN alarm Relay Mode, Reset Mode, ALT alarm Relay Mode, Reset Mode, OK alarm Relay Mode, Reset Mode)
- (1CH, DAN set value, Delay time, Sequence, ALT set value, Delay time, Sequence, OK Low voltage, OK High voltage, Suppression value)
- (2CH, DAN set value, Delay time, Sequence, ALT set value, Delay time, Sequence, OK Low voltage, OK High voltage, Suppression value)
- (3CH, DAN set value, Delay time, Sequence, ALT set value, Delay time, Sequence, OK Low voltage, OK High voltage, Suppression value)
- (4CH, DAN set value, Delay time, Sequence, ALT set value, Delay time, Sequence, OK Low voltage, OK High voltage, Suppression value)

Ex.)

DAN alarm relay mode : De-energized alarm(D-E), Reset mode : Auto-reset(N-L)

ALT alarm relay mode : De-energized alarm(D-E), Reset mode : Auto-reset(N-L)

OK alarm relay mode : Energized alarm(E), Reset mode : Self hold(L)

DAN alarm set value : 60 μ m, Delay time : 0.5sec, Sequence : 4x

ALT alarm set value : 40 μ m, Delay time : 0.5sec, Sequence : 4x

OK alarm Low set value : -1.4V, High set value : -17V

Suppression : 1.5%

```
CON,D-E,N-L,D-E,N-L,E,L
1CH,60,0.5,4,40,0.5,4,-1.4,-17.0,1.5
2CH,60,0.5,4,40,0.5,4,-1.4,-17.0,1.5
3CH,60,0.5,4,40,0.5,4,-1.4,-17.0,1.5
4CH,60,0.5,4,40,0.5,4,-1.4,-17.0,1.5
```

DATA : The order to store data into the memory card is written below.
 The memory card slot unit has a buffer size for 20 data. When the memory card is non-inserted, 20 data are stored onto the memory card slot unit, and are wrote the data to memory card at the time of memory card inserted.
 The data are deleted from old data and new data are stored.

(Time, 1CH Vibration Value, ALARM Condition, GAP Voltage, 2CH Vibration Value, GAP Value, ALERT Condition, 3CH•••, External Operation Contact)

Ex.)

Time : 12:34:50

1ch : vibration value : 250 μ m(DAN alarm condition), GAP voltage : -8.3V

2ch : vibration value : 160 μ m(ALT alarm condition), GAP voltage : -9.5V

3ch : vibration value : Input abnormal alarm condition, GAP voltage : -21V

4ch : vibration value : 100 μ m, GAP voltage : -9.2V

Sequence : ON

In this example, data displayed is shown below.

TIME,1ch,STA,GAP,2ch,STA,GAP,3ch,STA,GAP,4ch,STA,GAP,CTR
 12:34:50,250,DAN,-8.3,160,ALT,-9.5,0,OK,-21.0,100,,-9.2,SEQ



- **If the power supply of VM-15 is turn off, The data collected to buffer are deleted.**



- **Alarm Status (STA) or External Operation Contact (CTR) may not be displayed depending upon the timing of the sampling.**



- **The data storage time may result in unstable depends on the timing of sampling.**

6-1 DIGITAL INDICATOR DESCRIPTION

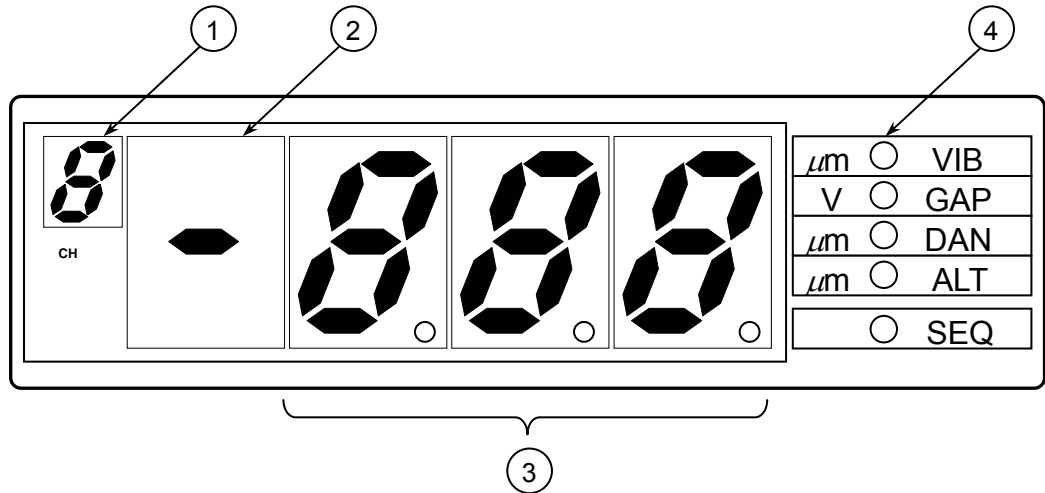

① CHANNEL DISPLAY (CH Dis.)

Displays the number of the channel that currently the set value is displayed or specification setup is in progress.

While the value is being collected, the display is constantly on. When the specification setup can be changed, the display flashes.

② MINUS DISPLAY

When the GAP voltage is indicated, '-' is in this space.

③ MEASURED VALUE/SPECIFICATION SETUP DISPLAY (MEAS Dis.)

Displays the measured value and specification setup condition.

When the specification setup change is available, the display flashes.

④ UNIT INDICATOR

The unit LED for the digitally displayed values, such as measured values, alarm setup values, etc, is on.

6-2 MEMORY CARD FUNCTION SETUP

Explains how to setup date (yy/mm/dd), time (hh/mm/ss) or sampling time from the Measured Vibration Value (MVV) display.

6-2-1 MEMORY CARD FUNCTION PROCEDURE

After the protection is cancelled, it is possible to set up the memory card function. In order to change a main item, use the 'MENU' key or 'SHIFT + MENU' key. In order to change a sub item, use the '▲' or '▼' key.

The chart below is the memory card function setup procedure.

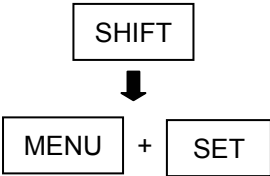
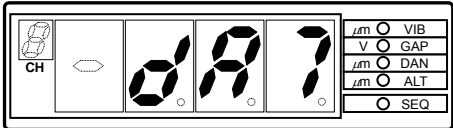
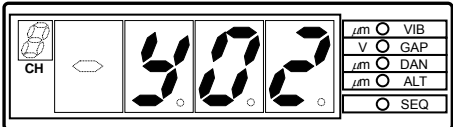
Step	Key Operation	Items	Display
1	Press 'SHIFT', then press 'MENU' and 'SET' simultaneously for more than 5 sec. 	Protection cancellation	Picture below is shown for 3 sec. as memory card function setup mode. This is the date setup screen. 
2		Year (20xx) setup screen	After picture in step 1 is shown for 3 sec., year (20xx) setup screen appears. 

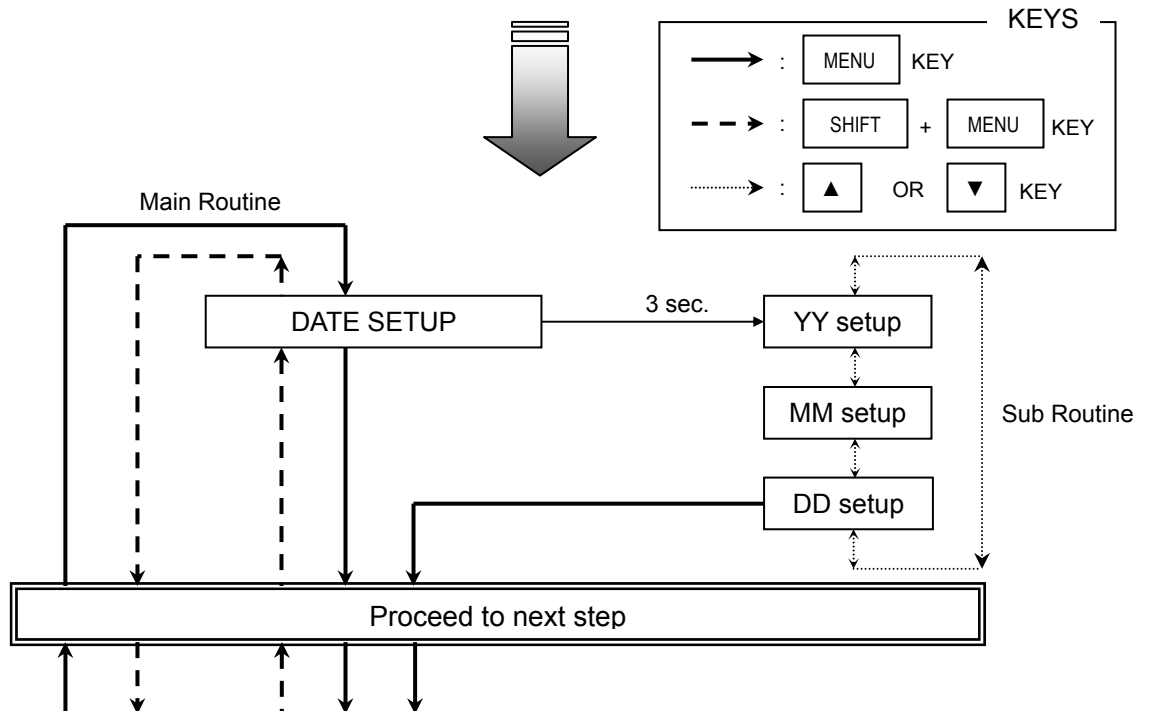

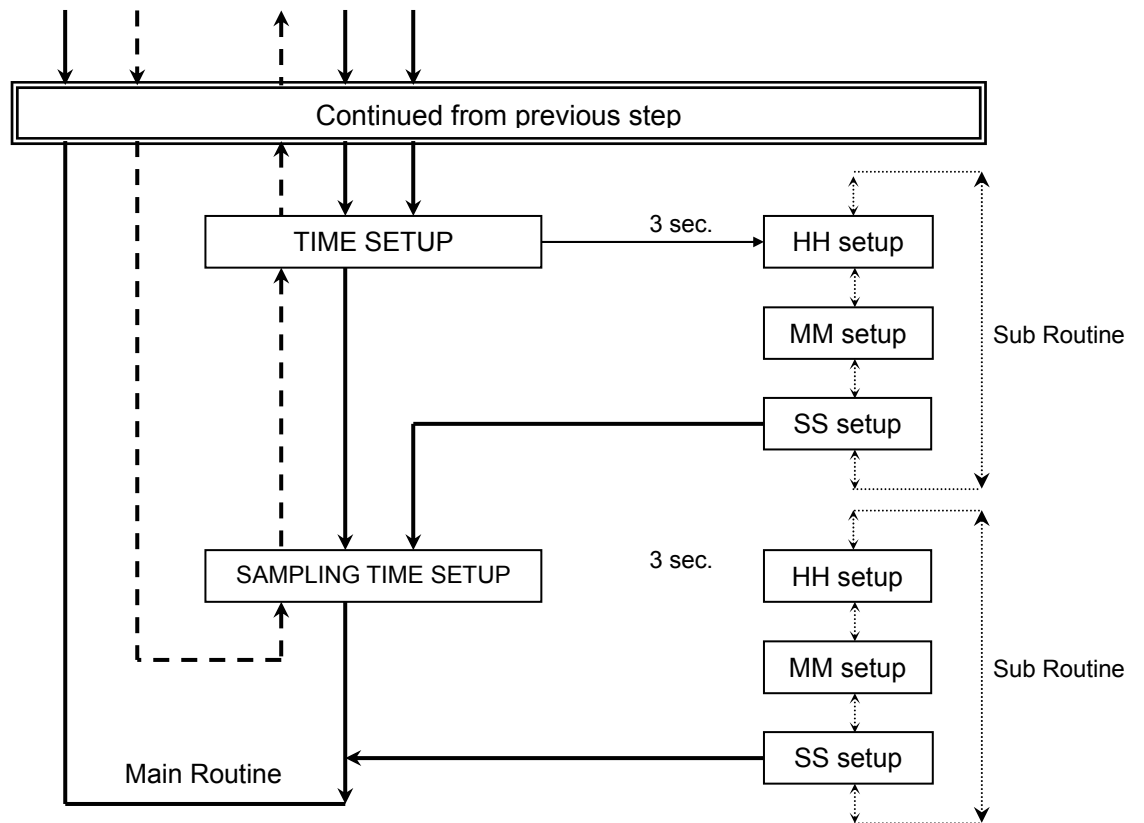

On each setup screen press the 'MENU' key continuously for more than 5 sec., and the MVV screen will return.

If the situation remains unchanged for approx. 1 minute, the MVV screen will automatically return.





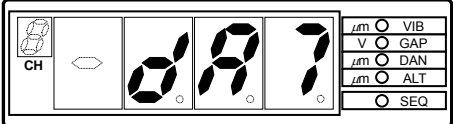
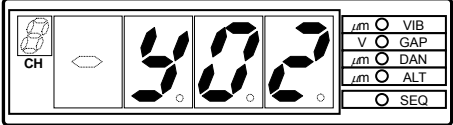
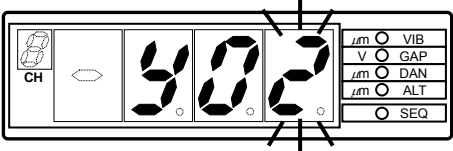
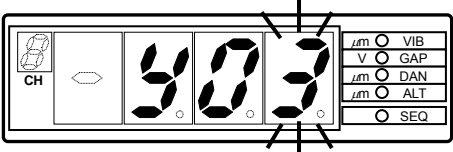
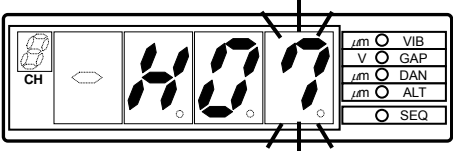

6-2-2 DATE (YY/MM/DD) SETUP

After the procedure in Section 6-2-1 is completed, in order to cancel the protection, memory card function setting screen appears. To change the setup values, follow the procedure below.

Step	Key Operation	Items	Display
Refer to Section 6-2-1 and go to memory card function setup mode.			
1	<p style="text-align: center;">MENU</p> <p>Use 'MENU' to select date setup screen.</p> <p style="text-align: center;">▲ ▼</p> <p>Use '▲' or '▼' to select item.</p>	Select date setup screen	<p>Picture below shows date setup screen is selected.</p>  <p>After picture above is shown for 3 sec., year (20xx) setup screen appears.</p> 
2	<p style="text-align: center;">SET</p> <p>Press 'SET', and far right number of year setup flashes. Setup number can be changed.</p>	Setup value change possible	
3	<p style="text-align: center;">▲ ▼</p> <p>Use '▲' and '▼' to change number. Use 'SHIFT + ▲' or 'SHIFT + ▼' to change position.</p>	Change setup value	<p>Picture below shows year setup is 2003.</p> 
4	<p style="text-align: center;">CHECK SET</p> <p>Press 'CHECK' and 'SET' simultaneously to confirm setup. When setup is confirmed, month setup screen appears automatically.</p>	Confirm setup value	<p>When setup is confirmed, month setup screen appears and far right number flashes.</p> 
Proceed to next step			

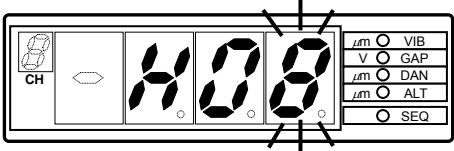
6. SCREEN DESCRIPTIONS AND KEY OPERATION METHOD

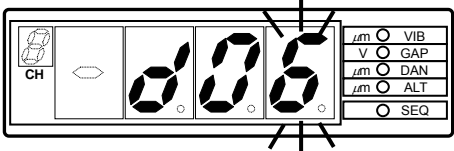
VM-15

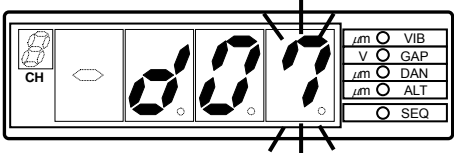
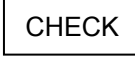
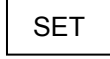
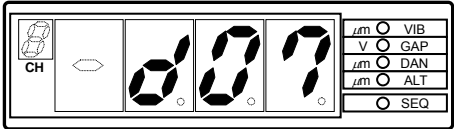
Step	Key Operation	Items	Display
Continued from previous step			
5	  Use '▲' and '▼' to change number. Use 'SHIFT + ▲' or 'SHIFT + ▼' to change position.	Change setup value	Picture below shows month setup is August. 
6	  Press 'CHECK' and 'SET' simultaneously to confirm setup. When the setup is confirmed, the day setup screen appears automatically.	Confirm setup value	When setup is confirmed, day setup screen appears and far right number flashes. 
7	  Use '▲' and '▼' to change number. Use 'SHIFT + ▲' or 'SHIFT + ▼' to change position.	Change setup value	Picture below shows day setup is the 7 th . 
8	  Press 'CHECK' and 'SET' simultaneously to confirm setup.	Confirm setup value	When setup is confirmed, number stops flashing. 

6. SCREEN DESCRIPTIONS AND KEY OPERATION METHOD

VM-15

6-2-3 TIME (HH/MM/SS) SETUP





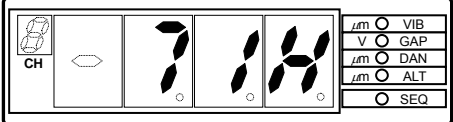
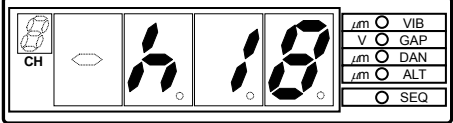
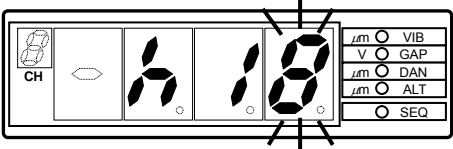
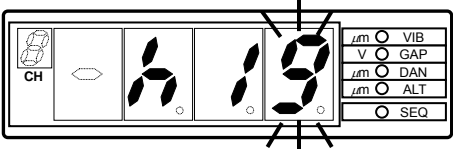
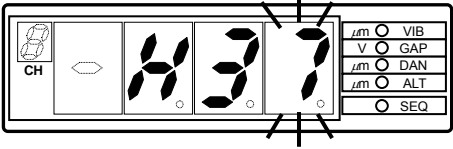



After the procedure in Section 6-2-1 is completed, in order to cancel the protection, memory card function setting screen appears. To change the setup values, follow the procedure below.

Time accuracy is +13 seconds ±52 par month at 25°C. Periodically time adjustment is recommended.

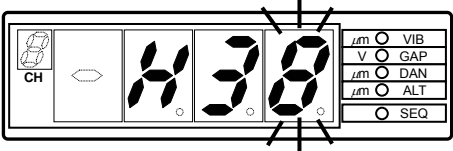
Step	Key Operation	Items	Display
Refer to Section 6-2-1 and go to memory function setup mode.			
1	<p style="text-align: center;">MENU</p> <p>Use 'MENU' to select time setup screen.</p> <p style="text-align: center;">▲ ▼</p> <p>Use '▲' or '▼' to select the item.</p>	Select time setup screen	<p>Picture below shows time setup screen is selected.</p>  <p>After picture above is shown for 3 sec., hour setup value appears.</p> 
2	<p style="text-align: center;">SET</p> <p>Press 'SET', and far right number of hour setup flashes. Setup number can be changed.</p>	Setup value change possible	
3	<p style="text-align: center;">▲ ▼</p> <p>Use '▲' and '▼' to change number. Use 'SHIFT + ▲' or 'SHIFT + ▼' to change position.</p>	Change setup value	<p>Picture below shows setup is 19:00 (7pm).</p> 
4	<p style="text-align: center;">CHECK SET</p> <p>Press 'CHECK' and 'SET' simultaneously to confirm setup. When setup is confirmed, minute setup screen appears automatically.</p>	Confirm setup value	<p>When setup is confirmed, minute setup screen appears and far right number flashes.</p> 
Proceed to next step			

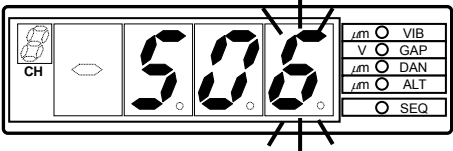
6. SCREEN DESCRIPTIONS AND KEY OPERATION METHOD

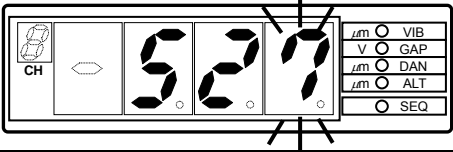
VM-15

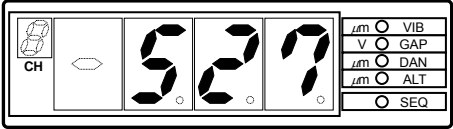
Step	Key Operation	Items	Display
Continued from previous step			
5	  Use '▲' and '▼' to change number. Use 'SHIFT + ▲' or 'SHIFT + ▼' to change position.	Change setup value	Picture below shows minute setup is the 38 th minute. 
6	  Press 'CHECK' and 'SET' simultaneously to confirm setup. When setup is confirmed, second setup screen appears automatically.	Confirm setup value	When setup is confirmed, second screen appears and far right number flashes. 
7	  Use '▲' and '▼' to change number. Use 'SHIFT + ▲' or 'SHIFT + ▼' to change position.	Change setup value	Picture below shows second setup is the 27 th second. 
8	  Press 'CHECK' and 'SET' simultaneously to confirm setup	Confirm setup value	When setup is confirmed, number stops flashing. 





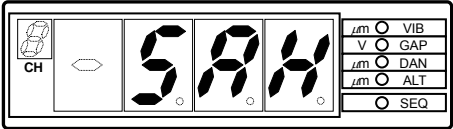
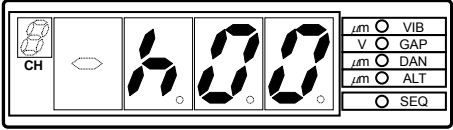
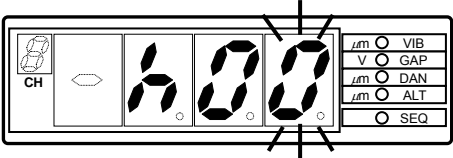
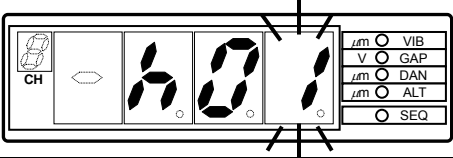
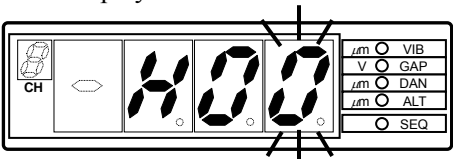

6-2-5 SAMPLING TIME SETUP

Sampling time can be setup between 10 sec. and 24 hrs., in 10 sec. increments. The data is stored with the time that is set. After the procedure in Section 6-2-1 is completed, in order to cancel the protection, memory card function setting screen appears. To change the setup values, follow the procedure below.

Step	Key Operation	Items	Display
Refer to Section 6-2-1 and go to memory function setup mode.			
1	<div style="text-align: center; border: 1px solid black; padding: 2px; width: fit-content; margin: 0 auto;">MENU</div> <p>Use 'MENU' to select sampling time setup screen.</p> <div style="display: flex; justify-content: center; gap: 10px; margin: 10px 0;"> <div style="border: 1px solid black; padding: 2px; width: 20px; height: 20px; text-align: center; line-height: 20px;">▲</div> <div style="border: 1px solid black; padding: 2px; width: 20px; height: 20px; text-align: center; line-height: 20px;">▼</div> </div> <p>Use '▲' or '▼' to select the item.</p>	Select sampling time setup screen	<p>C below shows sampling time setup screen is selected.</p>  <p>After picture above is shown for 3 sec., hour setup value appears.</p> 
2	<div style="text-align: center; border: 1px solid black; padding: 2px; width: fit-content; margin: 0 auto;">SET</div> <p>Press 'SET', and far right number of hour setup flashes. Setup number can be changed.</p>	Setup value change possible	
3	<div style="display: flex; justify-content: center; gap: 10px; margin: 0 auto;"> <div style="border: 1px solid black; padding: 2px; width: 20px; height: 20px; text-align: center; line-height: 20px;">▲</div> <div style="border: 1px solid black; padding: 2px; width: 20px; height: 20px; text-align: center; line-height: 20px;">▼</div> </div> <p>Use '▲' and '▼' to change number. Use 'SHIFT + ▲' or 'SHIFT + ▼' to change position.</p>	Change setup value	<p>Picture below shows sampling time setup is 1 hr.</p> 
4	<div style="display: flex; justify-content: center; gap: 10px; margin: 0 auto;"> <div style="border: 1px solid black; padding: 2px; width: fit-content; margin: 0 auto;">CHECK</div> <div style="border: 1px solid black; padding: 2px; width: fit-content; margin: 0 auto;">SET</div> </div> <p>Press 'CHECK' and 'SET' simultaneously to confirm setup. When setup is confirmed, second setup screen appears automatically.</p>	Confirm setup value	<p>When setup is confirmed, minute setup screen appears and far right number flashes. If 24 hr. setup, no value is shown on the display.</p> 
Proceed to next step			

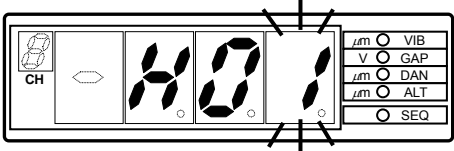
6. SCREEN DESCRIPTIONS AND KEY OPERATION METHOD

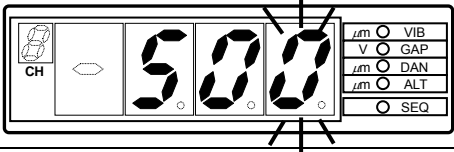
VM-15

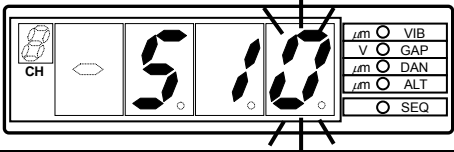
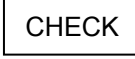
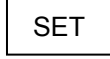
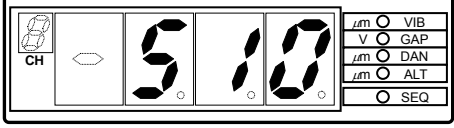
Step	Key Operation	Items	Display
Continued from previous step			
5	  Use '▲' and '▼' to change number. Use 'SHIFT + ▲' or 'SHIFT + ▼' to change position.	Change setup value	Picture below shows minute setup is 1 min. 
6	  Press 'CHECK' and 'SET' simultaneously to confirm setup. When setup is confirmed, second setup screen appears automatically.	Confirm setup value	When setup is confirmed, second setup screen appears and far right number flashes. If 24 hr. setup, no value is shown on the display. 
7	  Use '▲' and '▼' to change number. Use 'SHIFT + ▲' or 'SHIFT + ▼' to change position.	Change setup value	Picture below shows second setup is 10 sec. 
8	  Press 'CHECK' and 'SET' simultaneously to confirm setup.	Confirm setup value	When setup is confirmed, number stops flashing. 

Our products are built with electronic circuit components. There is a tendency to think that periodic inspections and maintenance (as is needed by cars and various machines) are not necessary. However, since electronic parts are consumable, periodic inspections and maintenance of the unit promotes optimal operation, lengthens its life span, and increases its reliability. SHINKAWA Electric Company provides a periodic inspection and maintenance program that begins after delivery.

7-1 CONTENTS OF PERIODIC INSPECTION AND MAINTENANCE

7-1-1 FUNCTION INSPECTION

Using instruments for testing and tools for accuracy checks, then confirming that function or accuracy levels reach the specified conditions. If necessary, alternate appropriate solutions are applied.

7-1-2 DISASSEMBLY INSPECTION

Inspecting the problems that decrease reliability, such as filthiness, corrosion or loose screws and connectors. Alternate appropriate solutions are then applied.

7-1-3 PART REPLACEMENT

'Consumable parts' is defined as those parts that are expected to be replaced within 10 years, under normal storage and usage conditions. To prevent any incompatibilities, it is strongly recommended that parts be replaced when they reach the end of their life span.

7-2 PERIODIC INSPECTION AND MAINTENANCE CHECK LIST

7-2-1 REPLACEMENT PERIODS

The life span of any parts or products, depending upon the condition under which they are used or stored. The life span of each component, under normal conditions, is written below. According to the replacement periods of VM-15 parts, refer to the VM-15 master instruction manual.

PRODUCTS	REPLACEMENT PERIOD (PART)	REPLACEMENT PERIOD (UNIT)
MEMORY CARD UNIT	5 YEARS (ELECTROLYSIS CONDENSOR) 5 YEARS (BATTERY)	10 YEARS

7-3 CONFIRMATION OF MEMORY CARD SLOT



Mandatory

- **The alarm operates.**
During the test, the OK alarm or other alarms may output. If necessary, consider alternate protection plans, such as disconnecting the circuit between the alarm contact output and the connecting system, etc.



Danger

- **During the test, the machine is not protected.**
- **In order to confirm the alarm operation, it is necessary for all other channels to be in normal condition (not alarm output condition).**

7-3-1 OPERATION CONFIRMATION METHOD



Mandatory

- **In order to perform the memory card unit operation confirmation, it is mandatory to perform the VM-15 main body operation confirmation.**

According to Section 6-2-5 sampling time setup, set the sampling time as 10 sec.

- **STAND-BY Status confirmation**
Insert the memory card, then turn the VM-15 power on. Confirm that the green LED, on the edge of the card slot, is lit.
- **Card Not Inserted Status confirmation**
Press EJECT button and remove the memory card, confirming that the red LED, on the edge of the card slot, turns on after approx. 10 sec. Reinsert the memory card and confirm that the red LED turns off after approx. 10 sec.



Warning

- **Use the EJECT button to remove the memory card. If the memory card is forcibly removed, it may cause damage.**

- **BUSY LAMP confirmation**
When the memory card is inserted, confirm that a yellow LED, on the edge of the card slot, flashes in approx. 10 sec. intervals.
- **DATA STORAGE confirmation**
Perform the VM-15 main body operation confirmation following the Section 8 MAINTENANCE AND INSPECTION METHOD in the master instruction manual. Confirm that the trend data collected during the operation confirmation is stored in the memory card.

While this monitor is in use and thought to be the cause of a problem, refer to the chart below to determine the reason for the problem, and its solution. If a solution cannot be found for the problem or any other symptoms that are not described in this section, contact the SHINKAWA Service Center nearest you for assistance.

Problem	How To Confirm	Solution
Green LED indicating STAND-BY Status is off.	Is the power of VM-15 main body on?	Turn on the power of VM-15.
	Is the VM-15 main body power supply terminal connection correct?	Connect the wiring correctly.
CARD NOT INSERTED Status lamp is still on.	Is the memory card inserted?	Insert the memory card.
	Is the memory card inserted all the way?	Insert the memory card all the way.
BUSY LAMP is off.	Is the sampling time setup appropriate?	Shorten the sampling time and reconfirm.
STAND-BY LAMP is flashing.	---	A communication error has occurred. Turn on the power again.
Data is not stored in the memory card.	Are any cards other than the memory card inserted?	Insert the CompactFlash™ (card adapter).
	---	A communication error has occurred. Turn on the power again.

Warranty

The warranty period for the delivered product shall be 3 years from the date of delivery from our factory. But the warranty period for the special order product and software shall be 1 year, and for the repairing parts shall be 6 months. In the event that the delivered product develops any defects within the warranty period for which Shinkawa Electric is liable, the defective part will be replaced or repaired in our factory at our own expense.

In the event that an engineer needs to be dispatched for repair purposes during the warranty period, travel expenses for the said engineer will be changed in accordance with the above item. The cost of repair will be borne by Shinkawa Electric.

However, the following are excluded from our warranty:

- (1) Any defects due to improper handling or operation by the user.
- (2) Any defects, the case of which is not attributable to Shinkawa Electric.
- (3) Any modifications or repairs made by others then Shinkawa Electric or persons commissioned by Shinkawa Electric.
- (4) Any handling, storage and operation under severe environmental conditions that exceed the design specifications.
- (5) Any defects due to fire, flood, earthquake, lightning and other Acts of God.
- (6) Thermocouples, glass electrodes and other items subject to severe wear as well as consumable such as recording paper and ink.
- (7) Other defects considered not to be attributable to Shinkawa Electric.

This warranty applies exclusively to the delivered product units.

Shinkawa Electric will not be held liable for consequential damage caused either directly or indirectly through a defect of the delivered product.

The warranty period and scope of machinery and equipment made by manufacturers other than Shinkawa Electric shall be in accordance with the conditions of the respective manufacturer, regardless of the provisions made above.



SHINKAWA Sensor Technology, Inc.

Hiroshima Factory

4-22 Yoshikawa-kogyodanchi, Higashi-hiroshima 739-0153, Japan

Tel. 0824-29-1118 Fax. 0824-29-0804

[Field support & Repair Dept] E-mail : service@sst.shinkawa.co.jp